

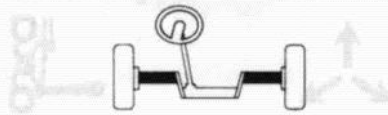

7



XM  
412-3/1

1



89-722

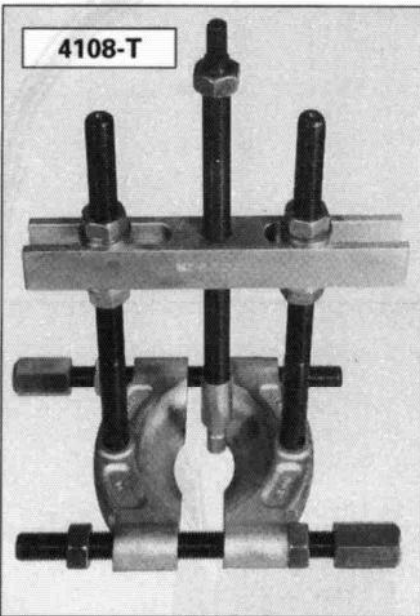
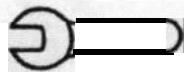

88-120

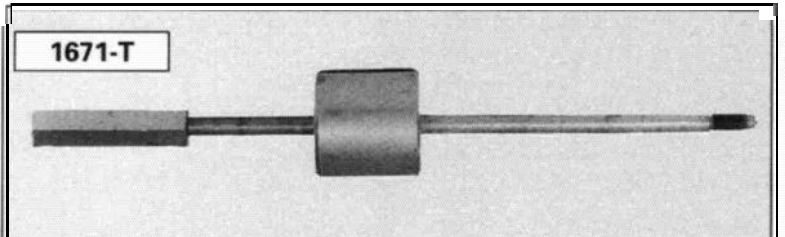

13-551

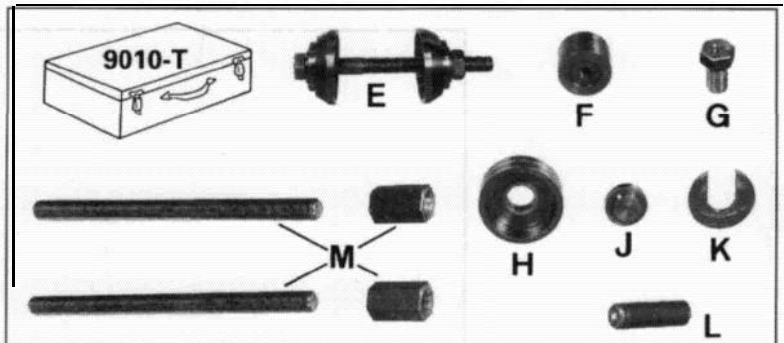

89-860

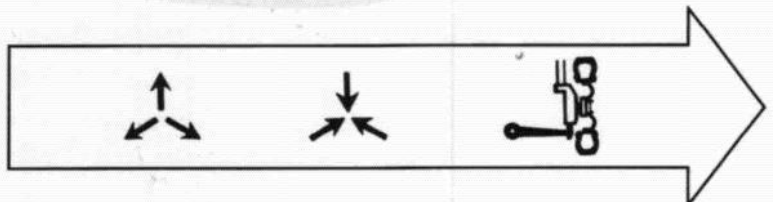

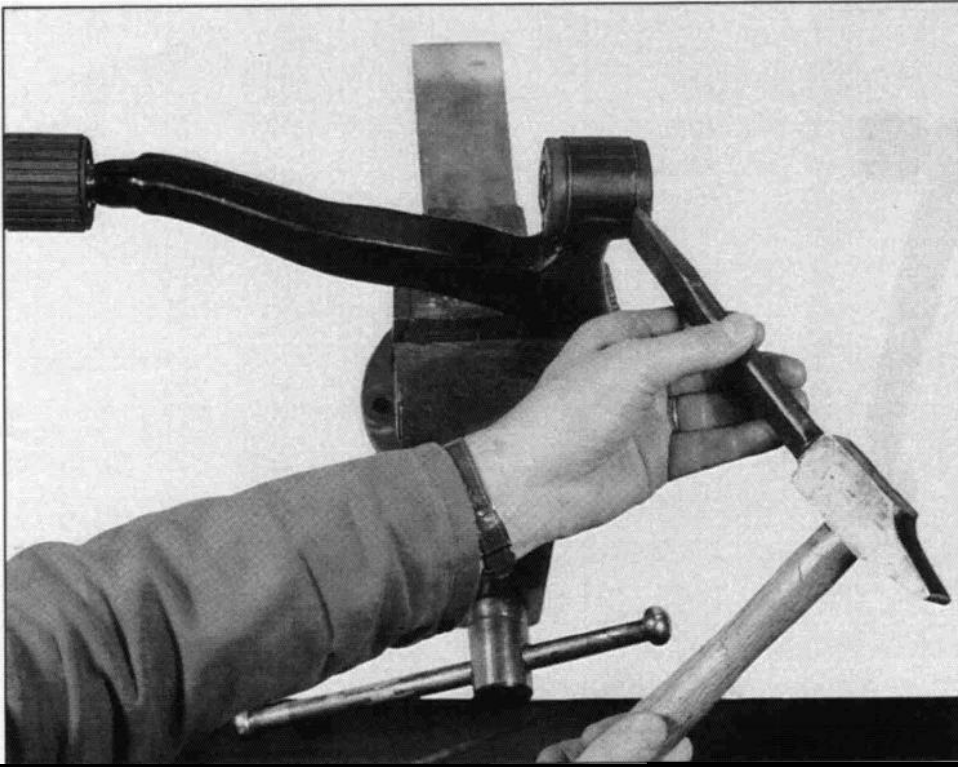
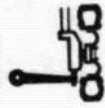

89-824

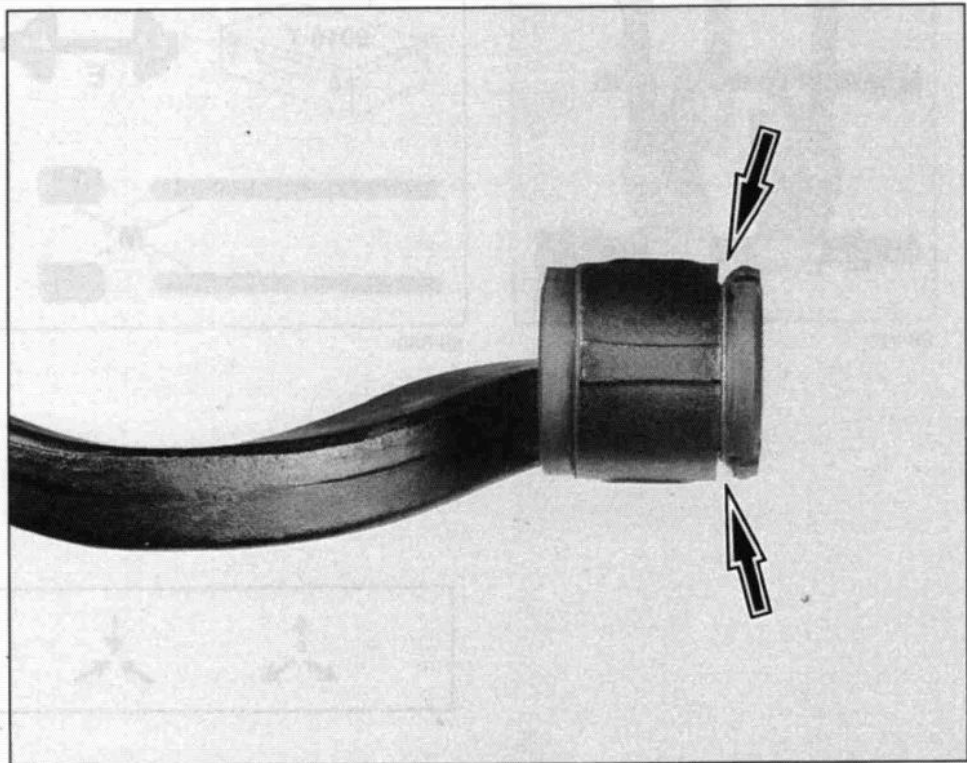
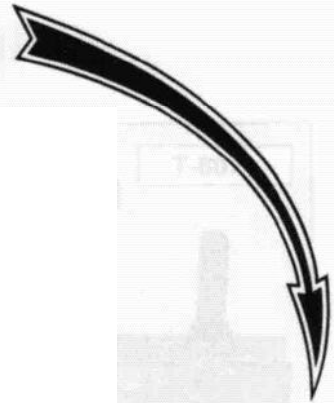

89-831



7

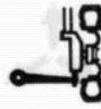

XM  
412-3/1

3

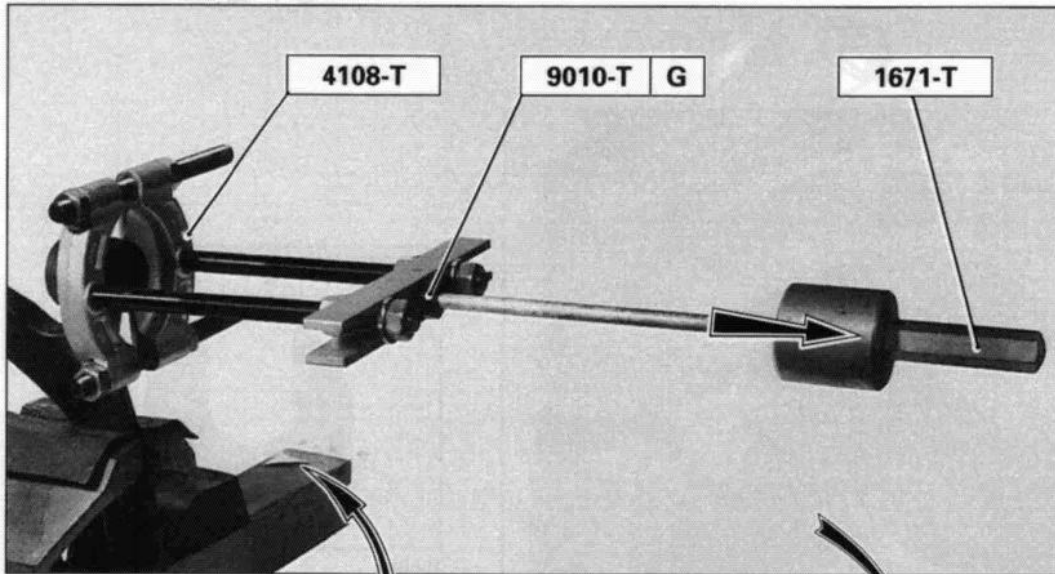

89-830

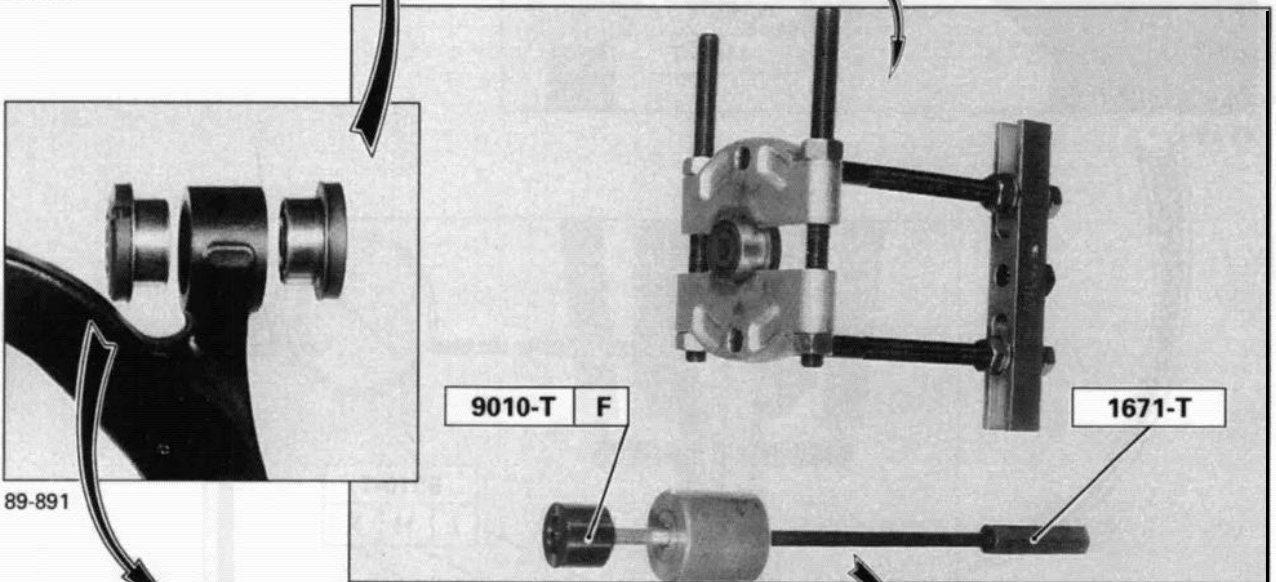

89-891

89-890

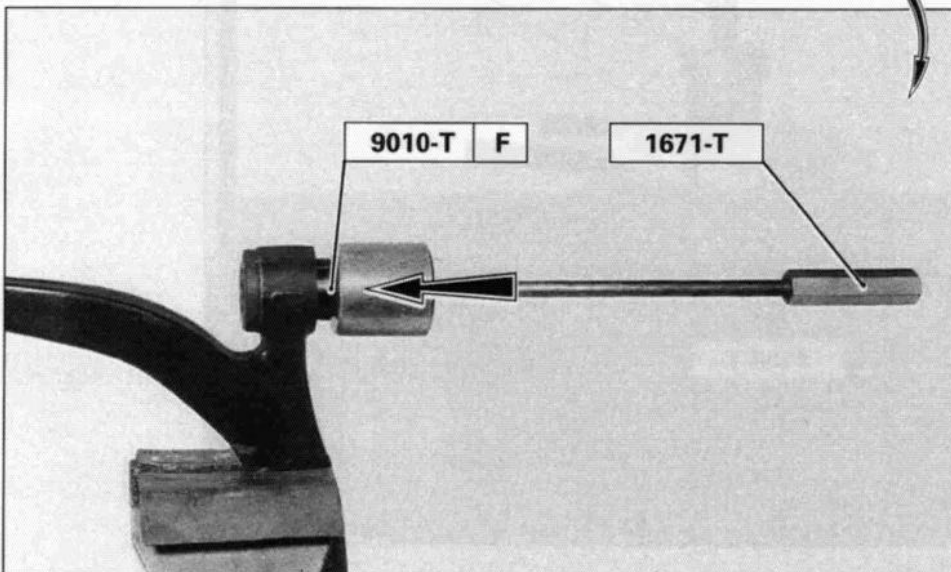

89-827

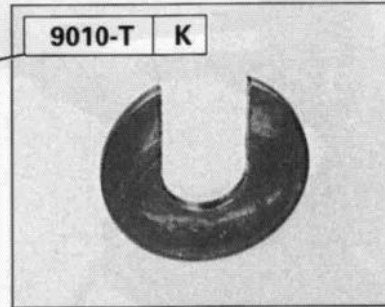
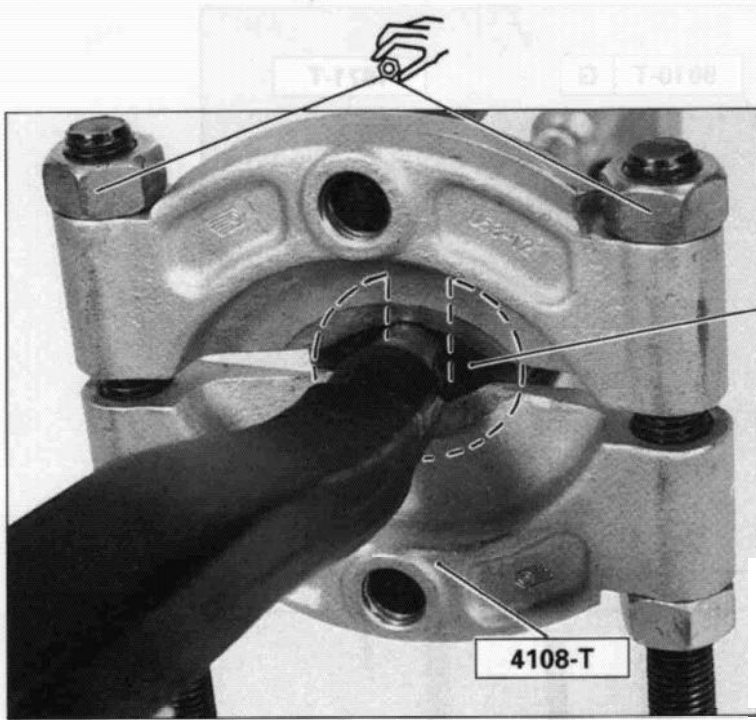
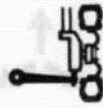

89-860

89-859

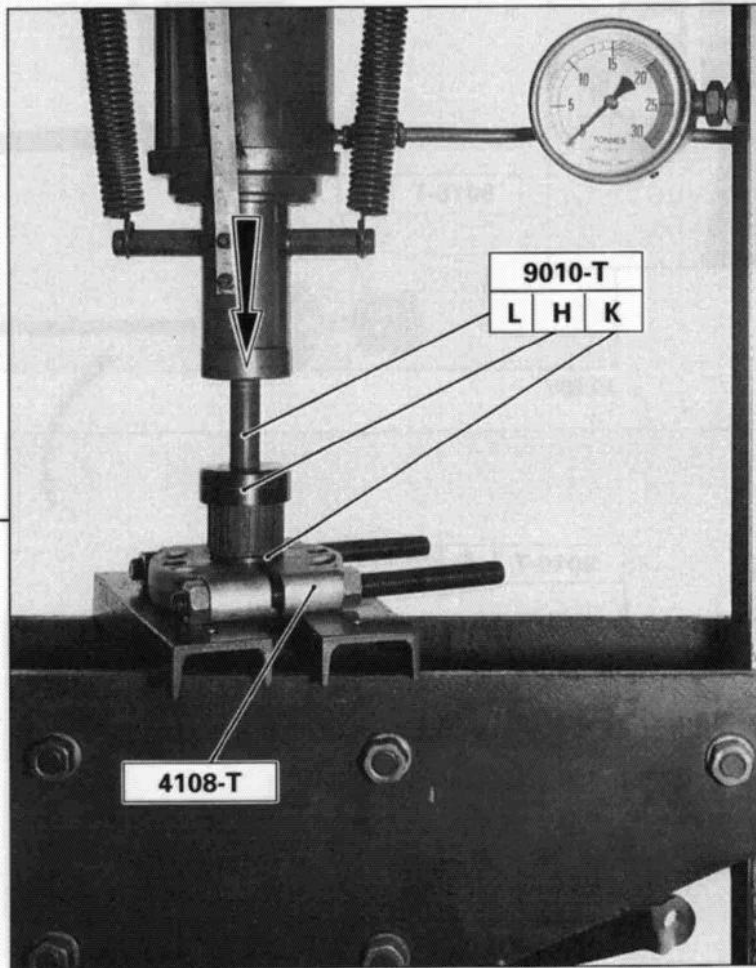

89-822

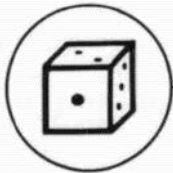



7

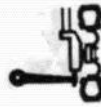

XM  
412-3/1

5

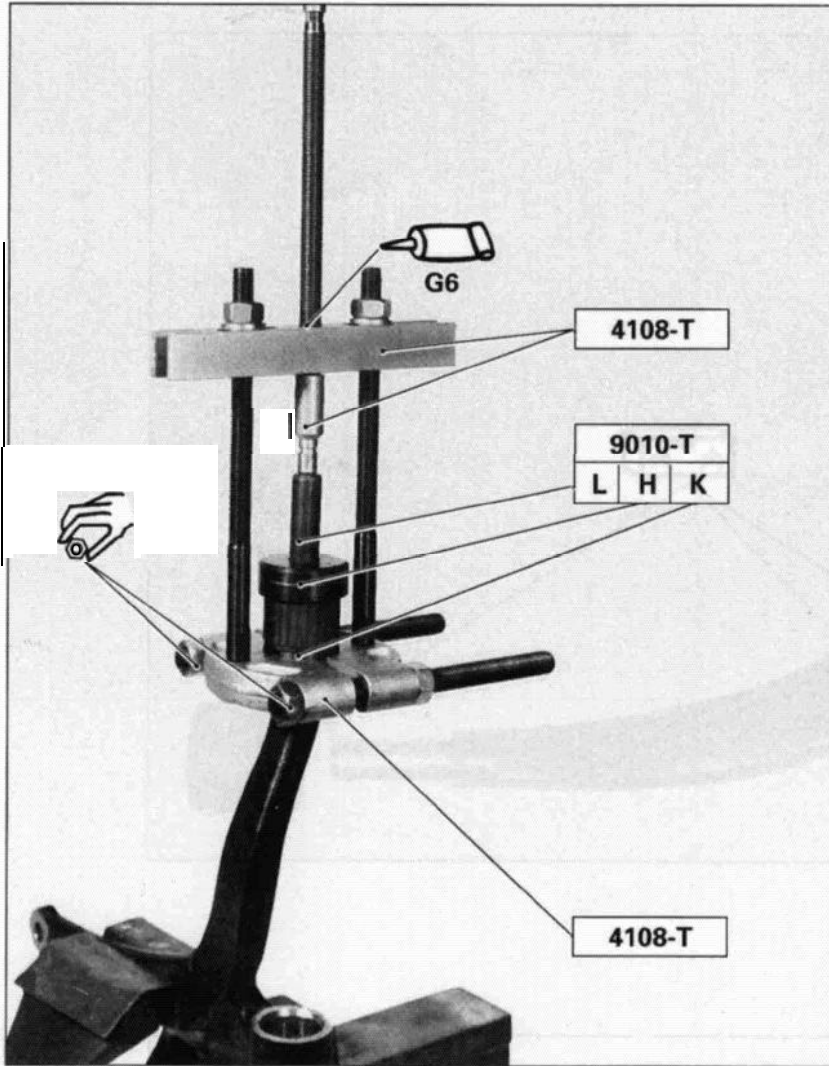

89-829

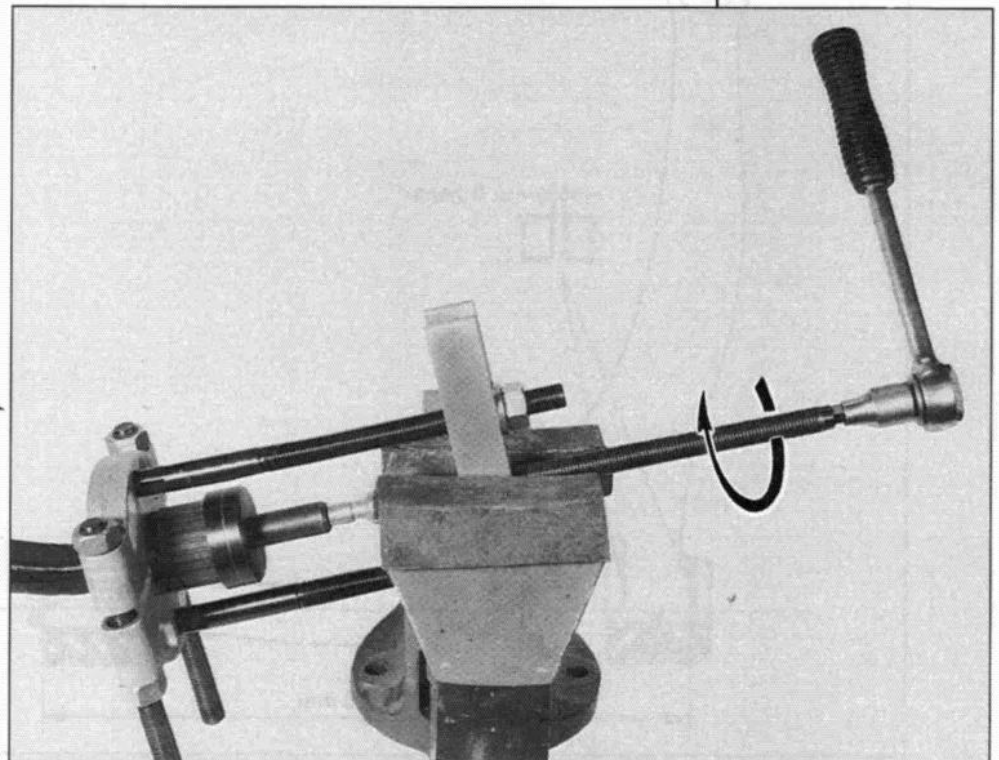
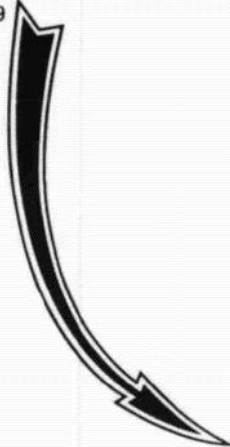

89-828

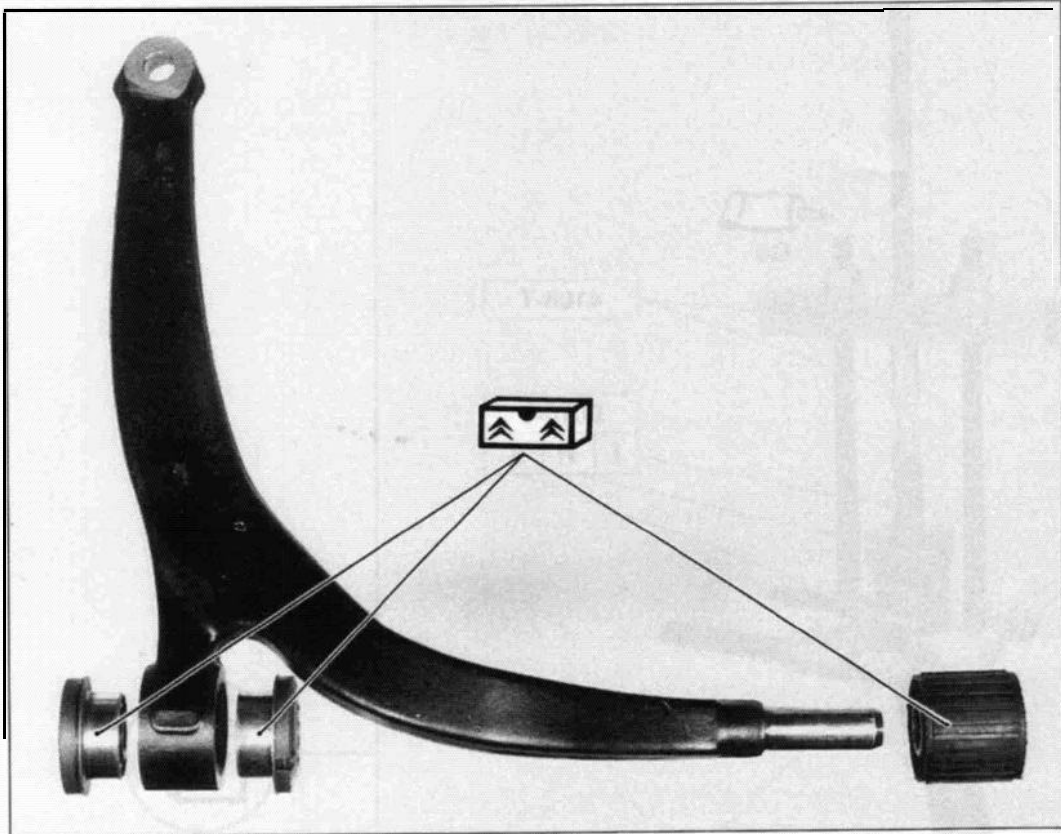
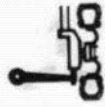
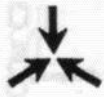

89-891

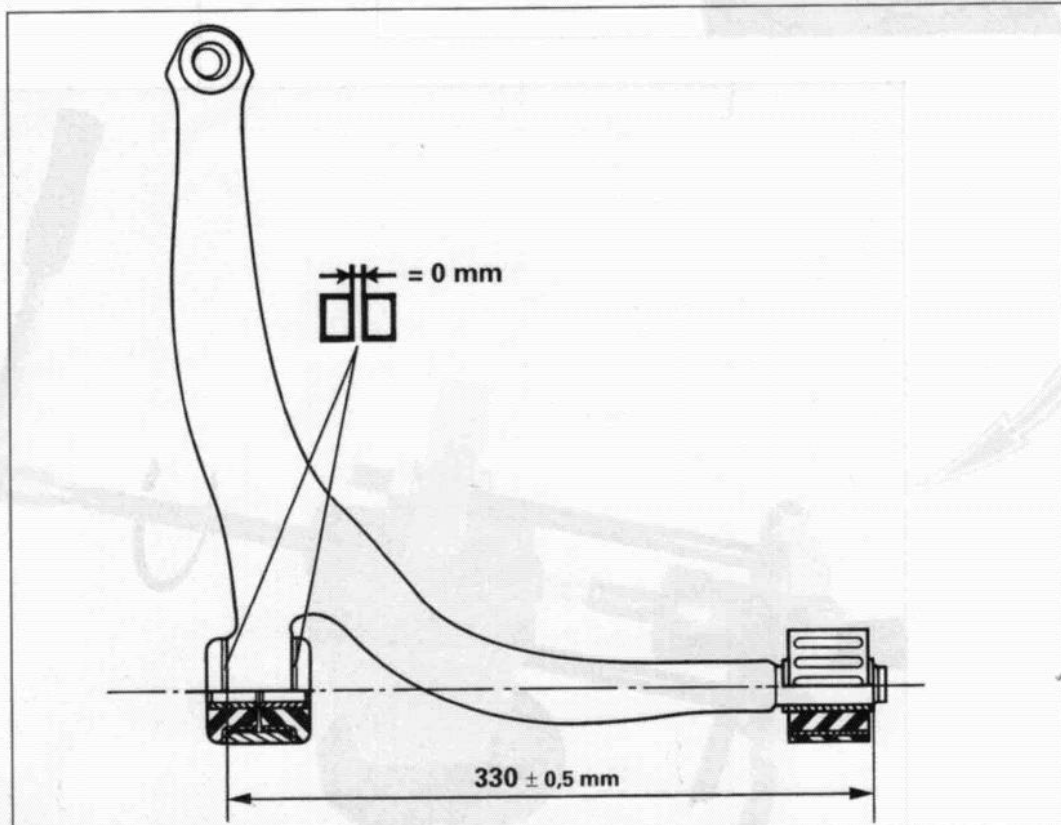

Y 41-7



7

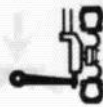
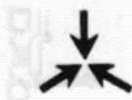

XM  
412-3/1

7

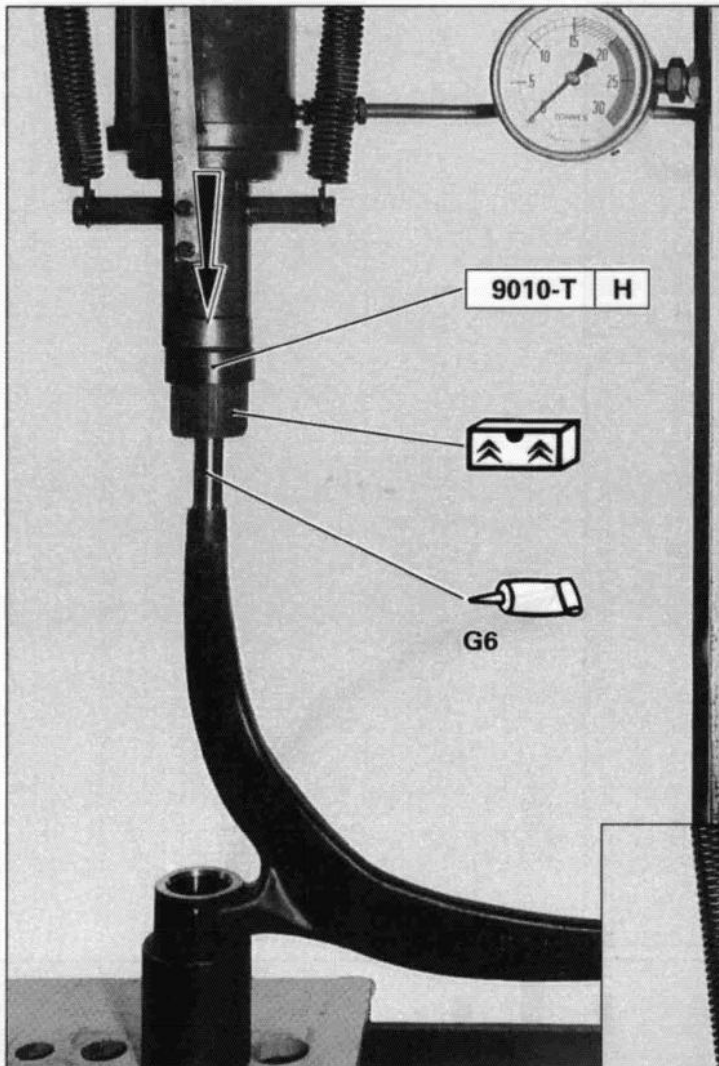

89-821

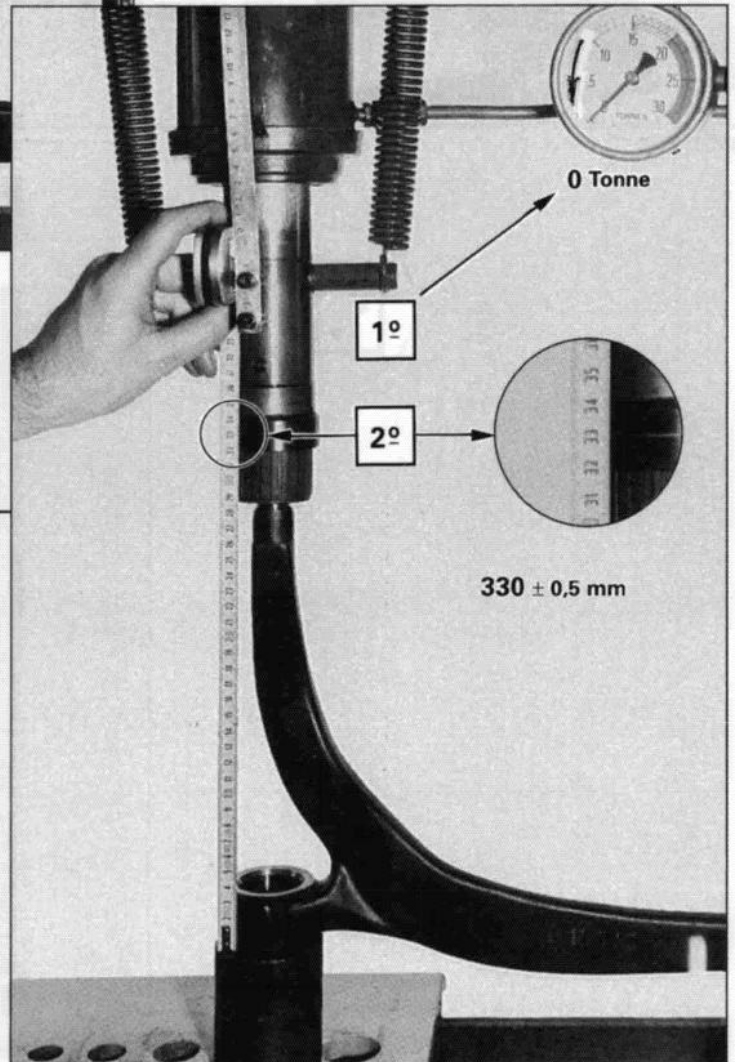
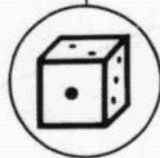

89-823

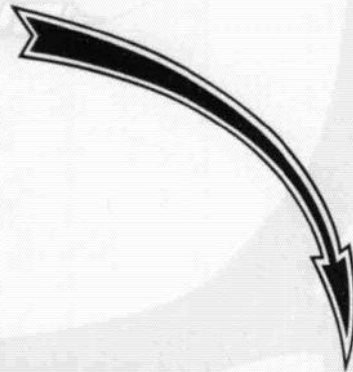
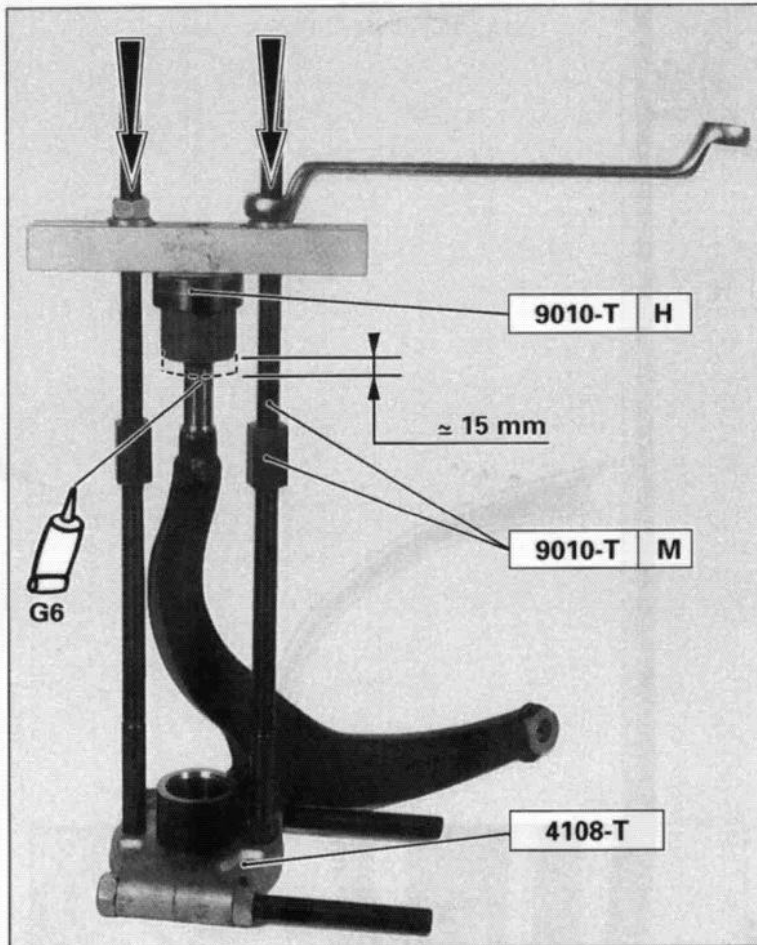

89-877

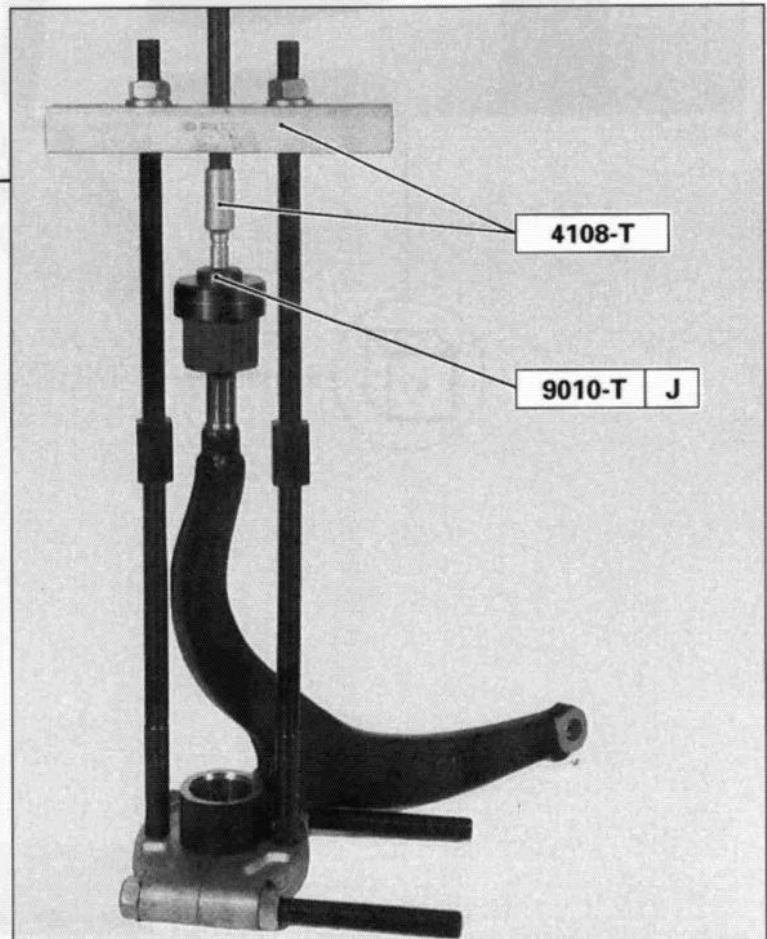
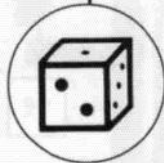

89-876





07



412-3/1 XM 9

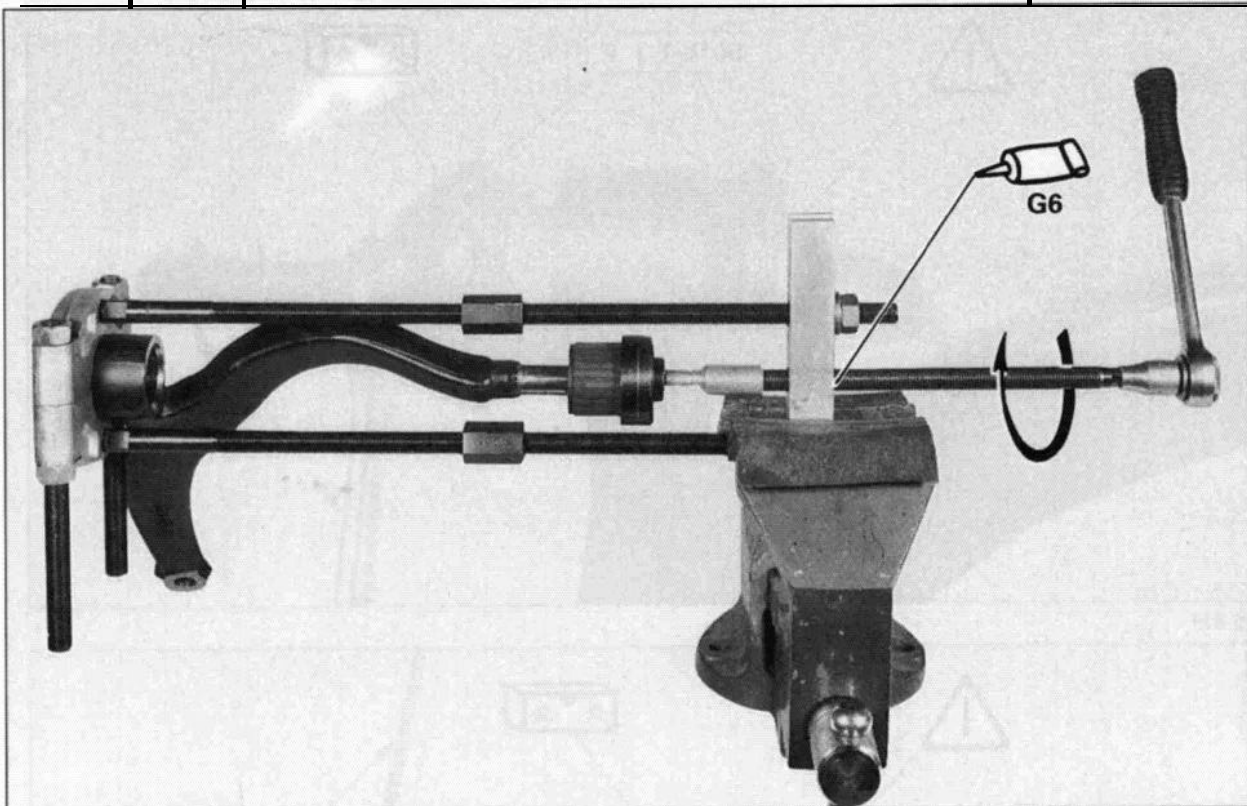

89-874

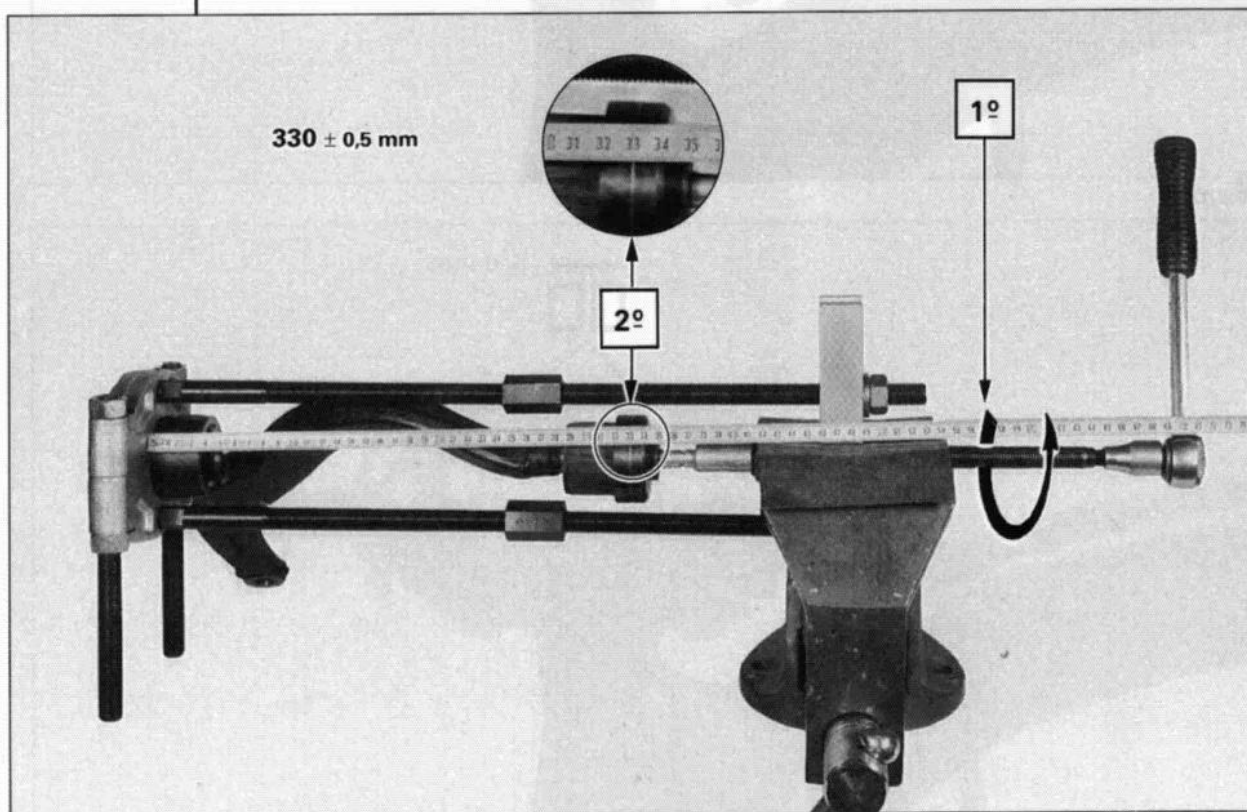
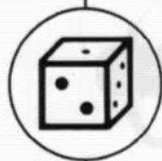

89-872

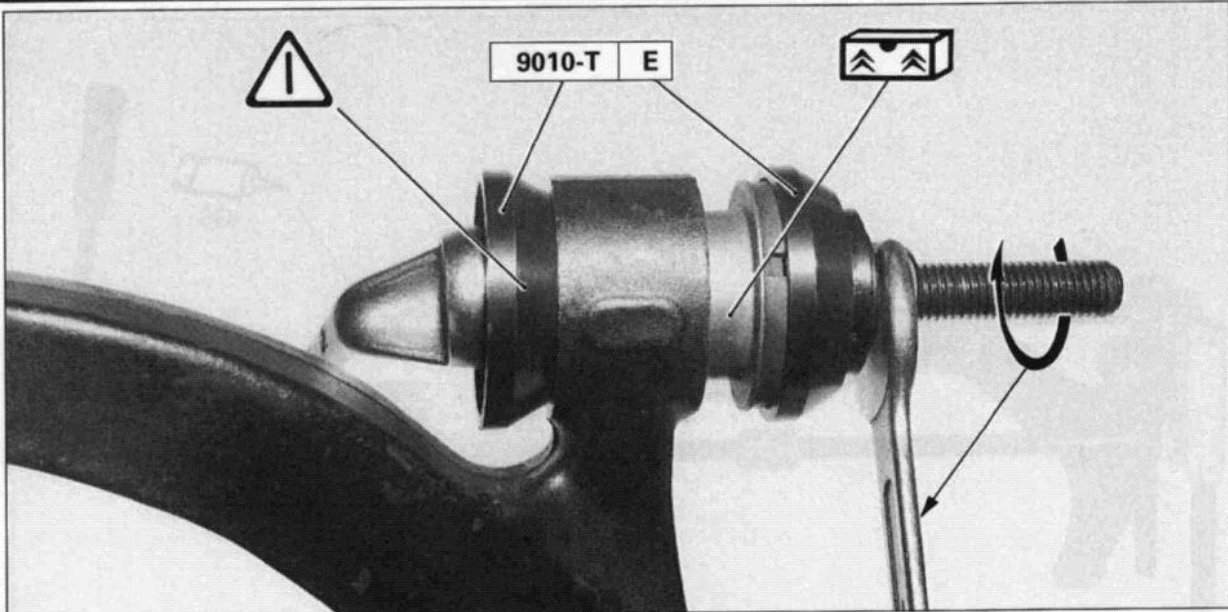
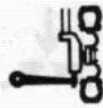
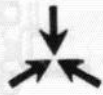

89-819

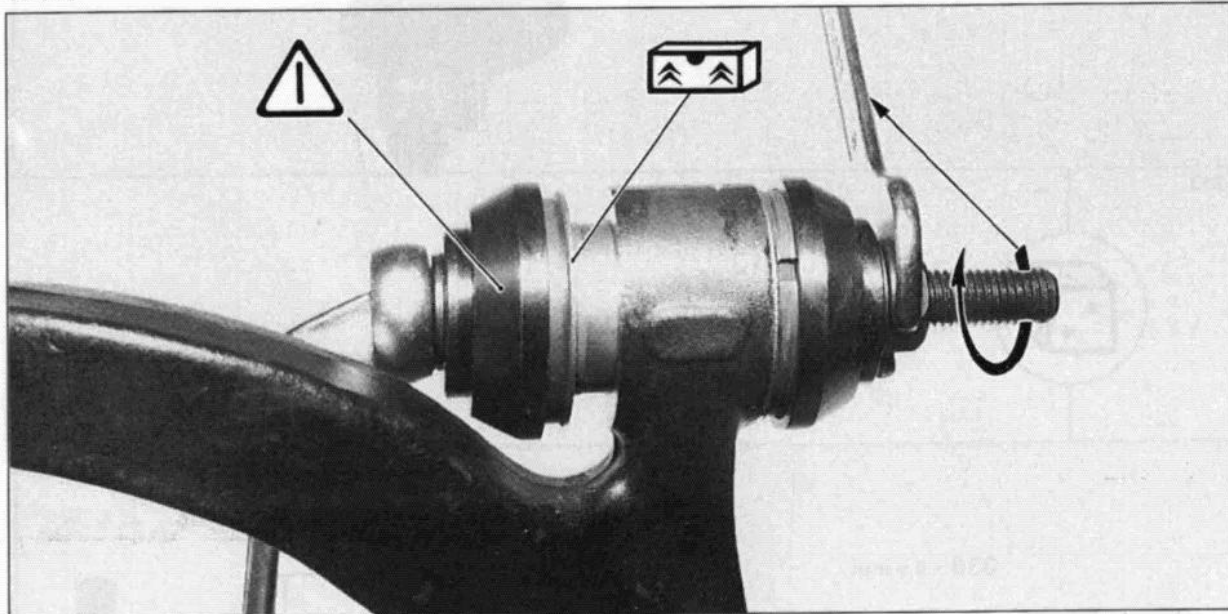

89-820

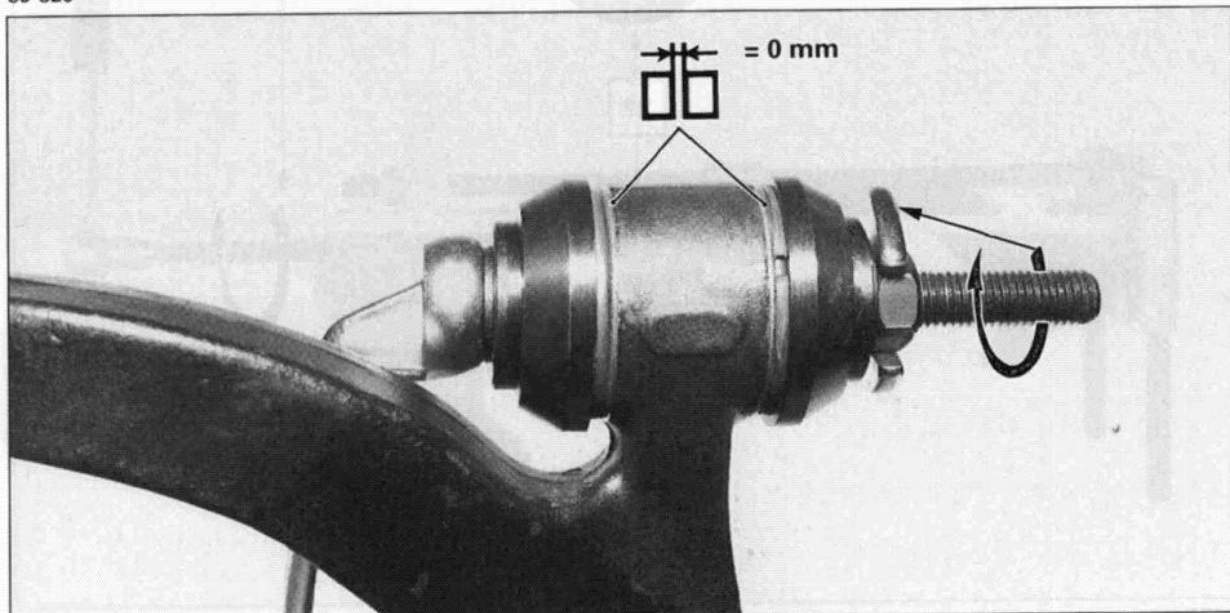

89-818