

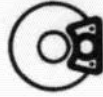

11



XM
453-3/1

1

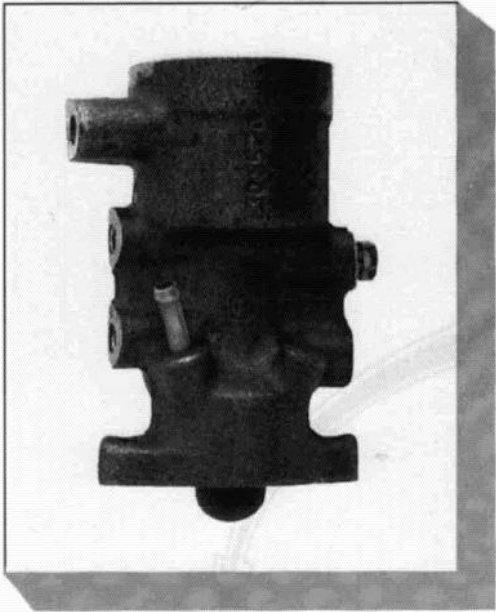

90-471

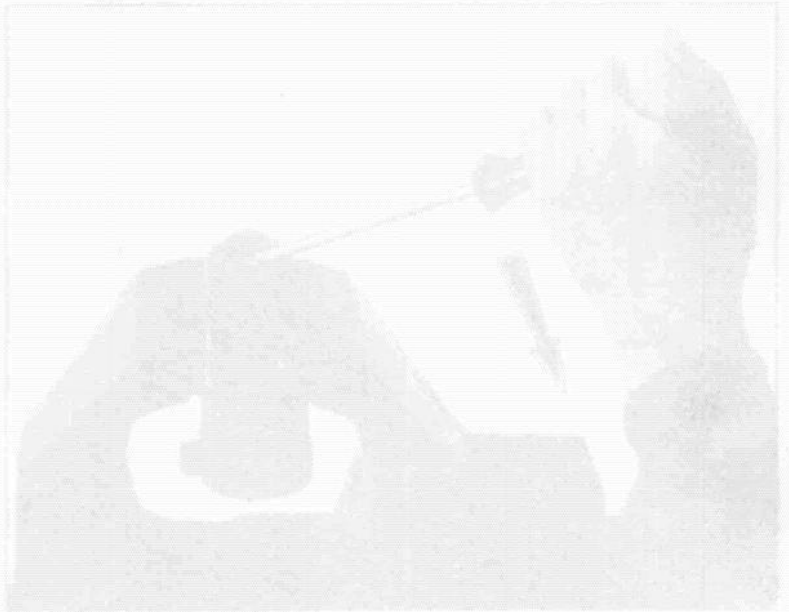

054-030

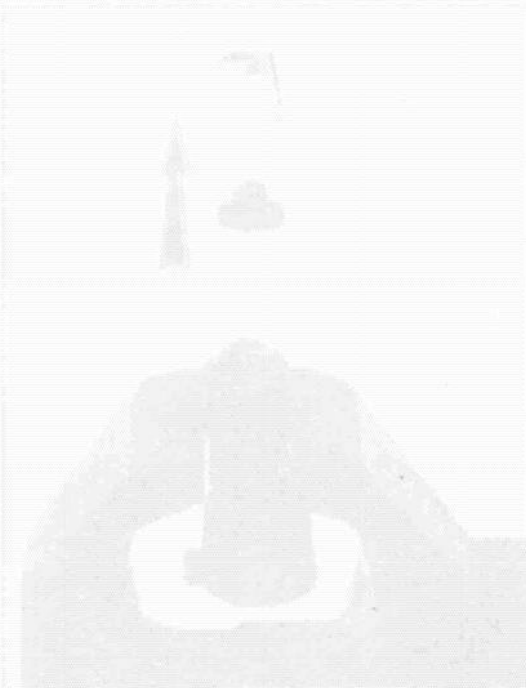

043-030



084-030

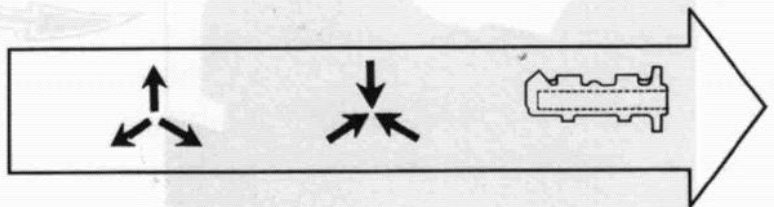

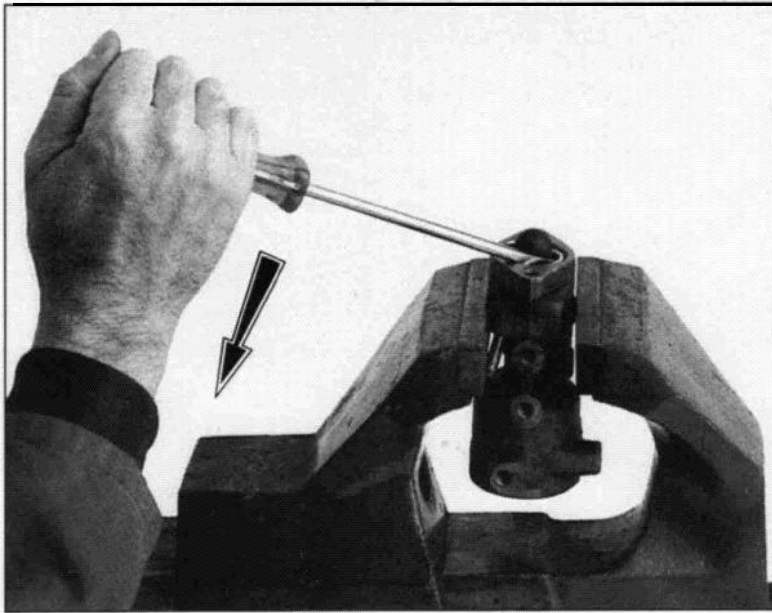
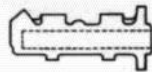

90-470

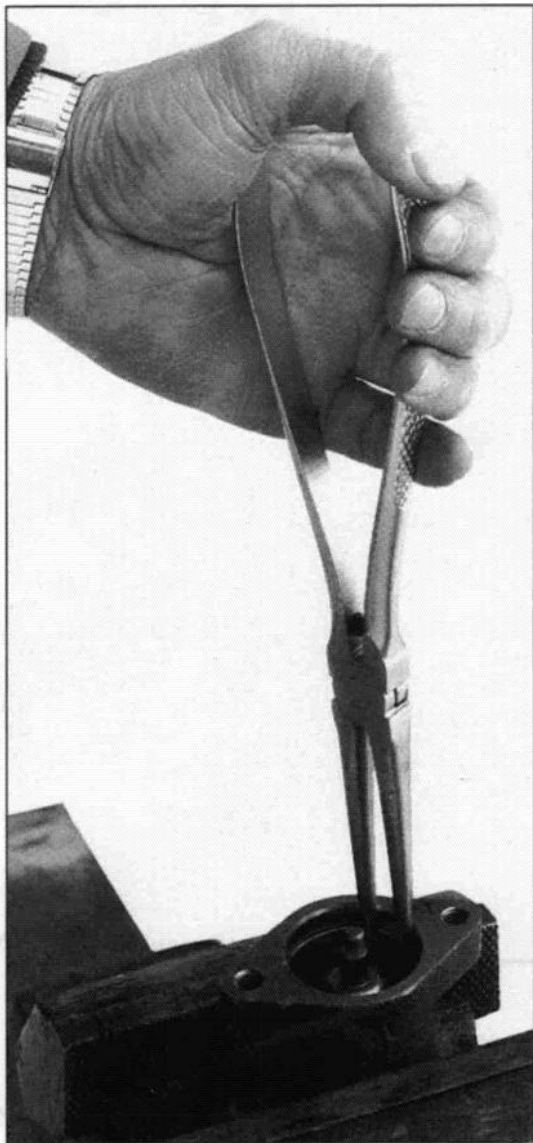

90-469

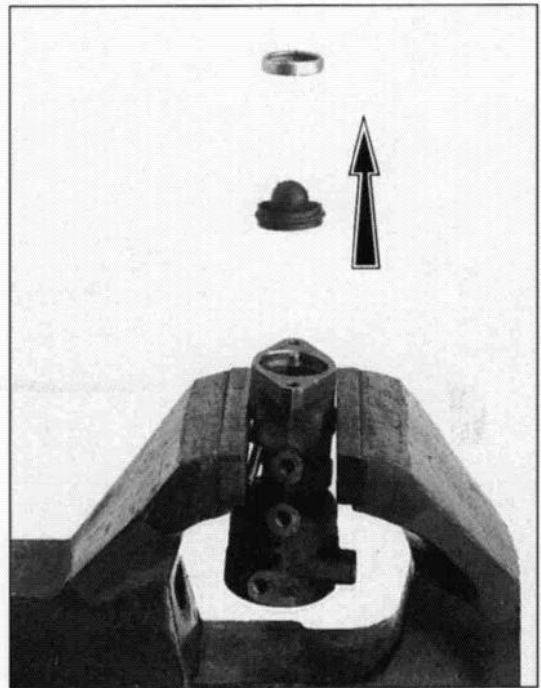

90-468

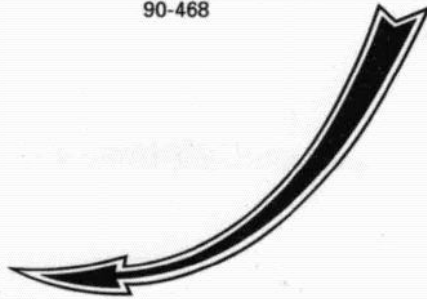



11

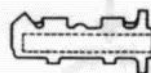

XM
453-3/1

5

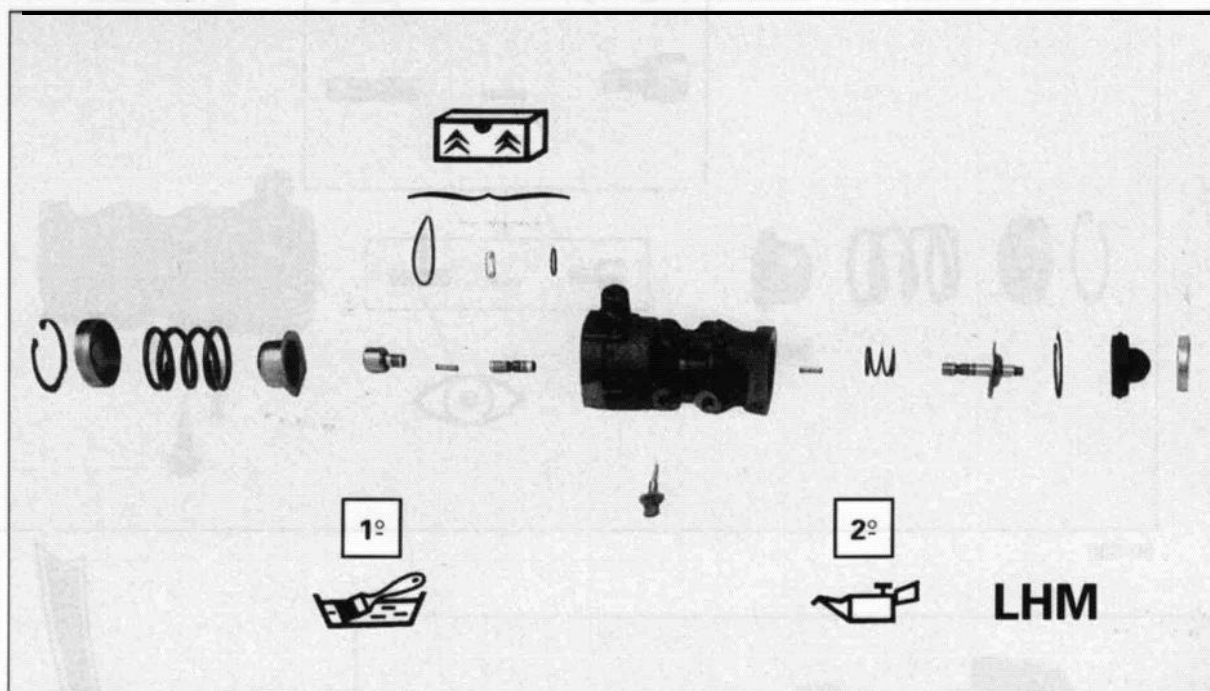

90-465

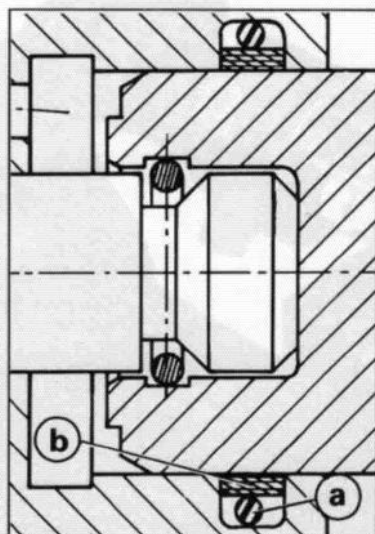
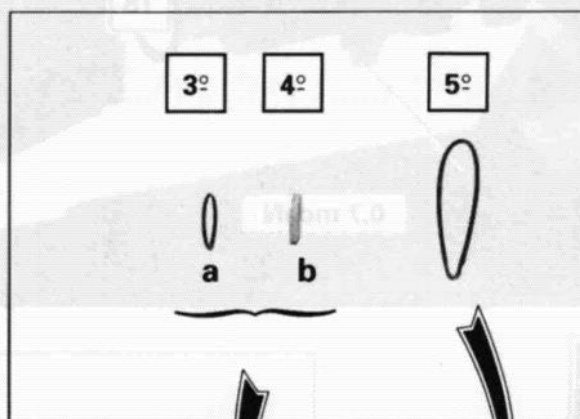
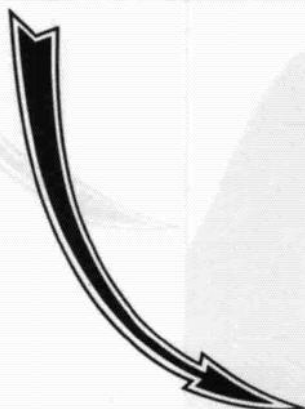

Y.45-20

90-504 — 90-461

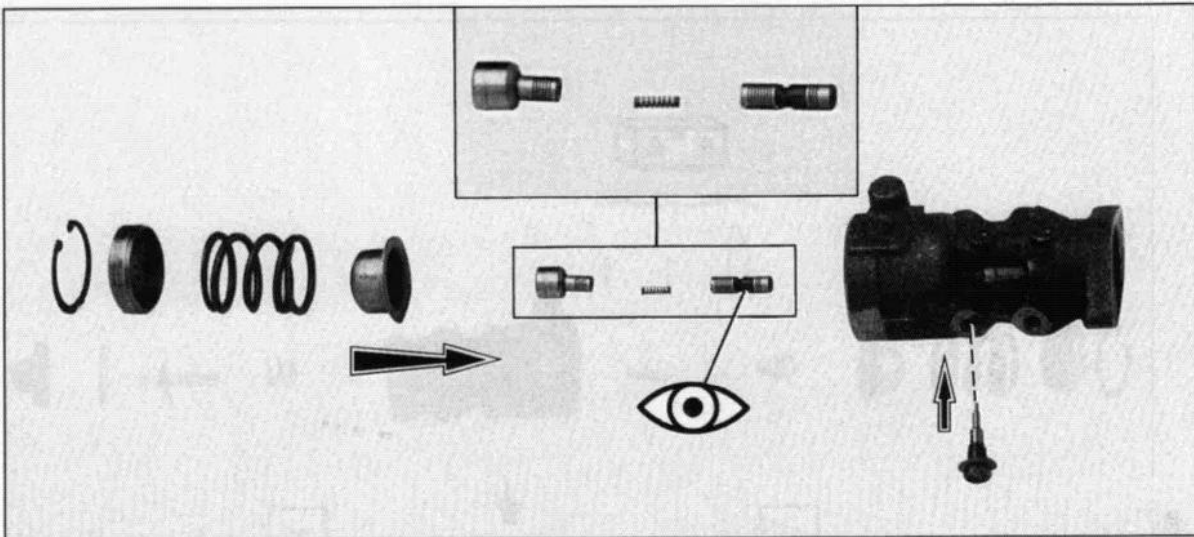
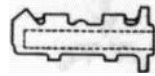
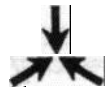

90-530

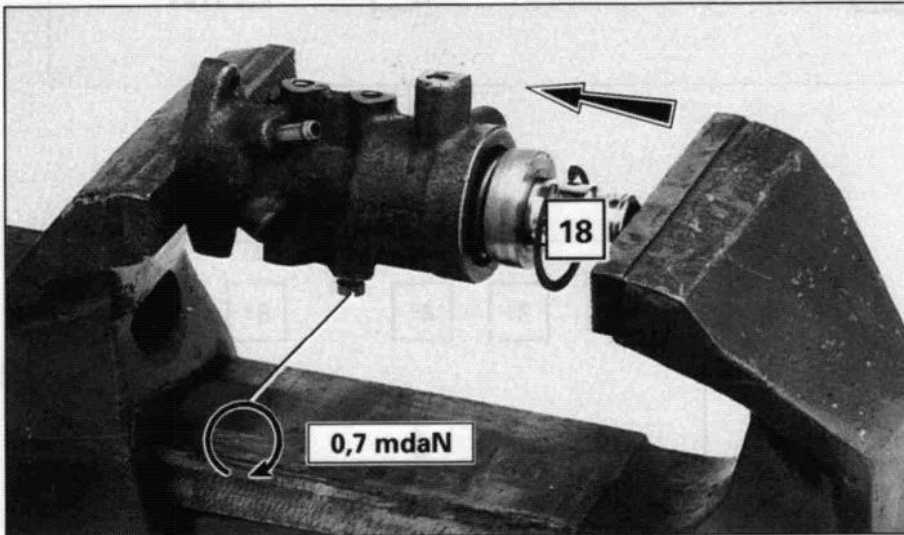

90-463

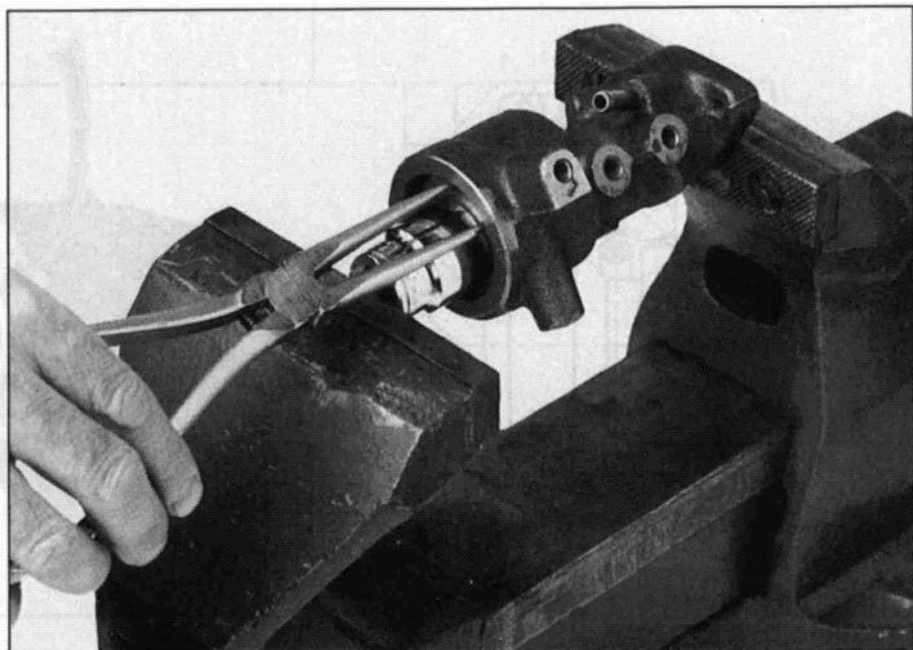

90-466



11

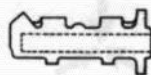
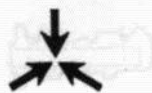

XM
453-3/1

7

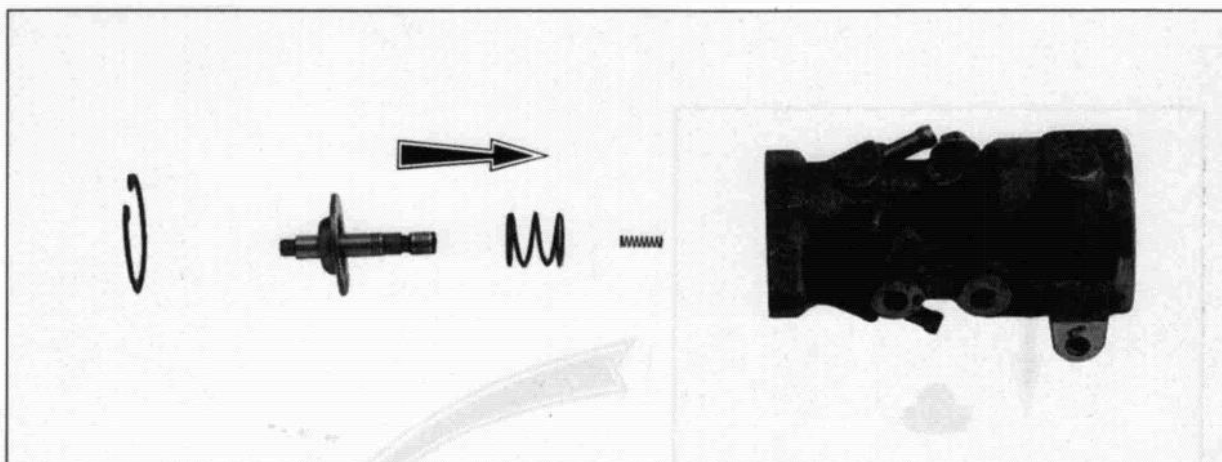

90-467

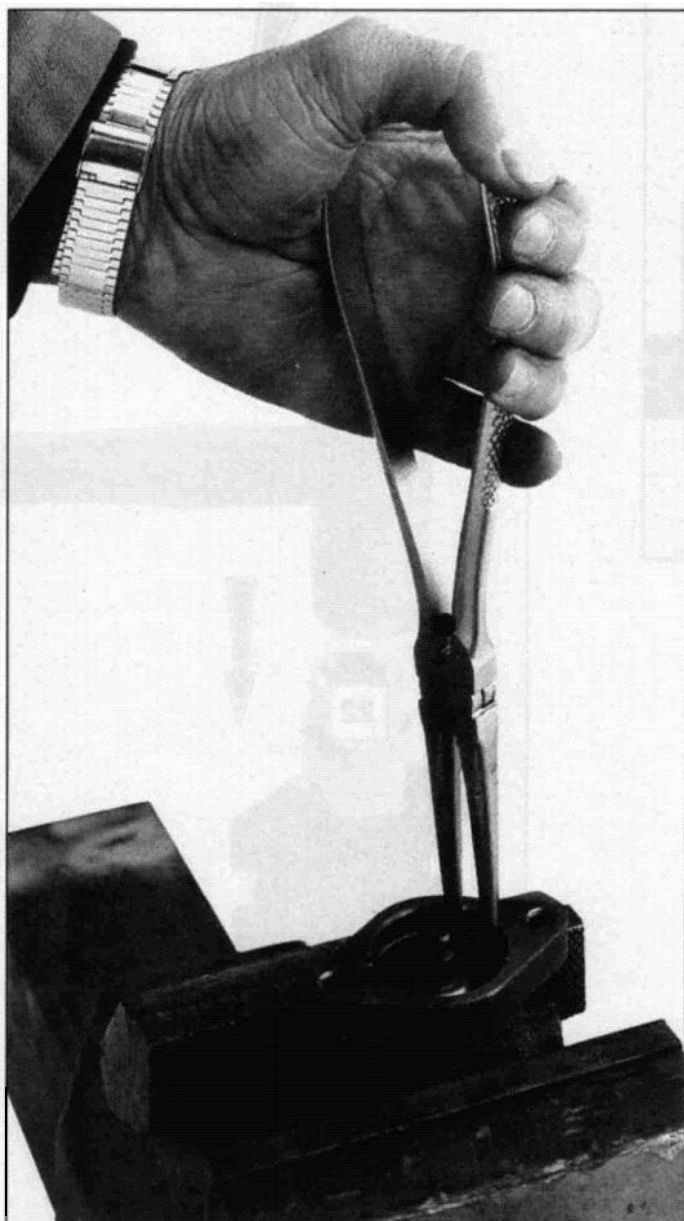

90-469



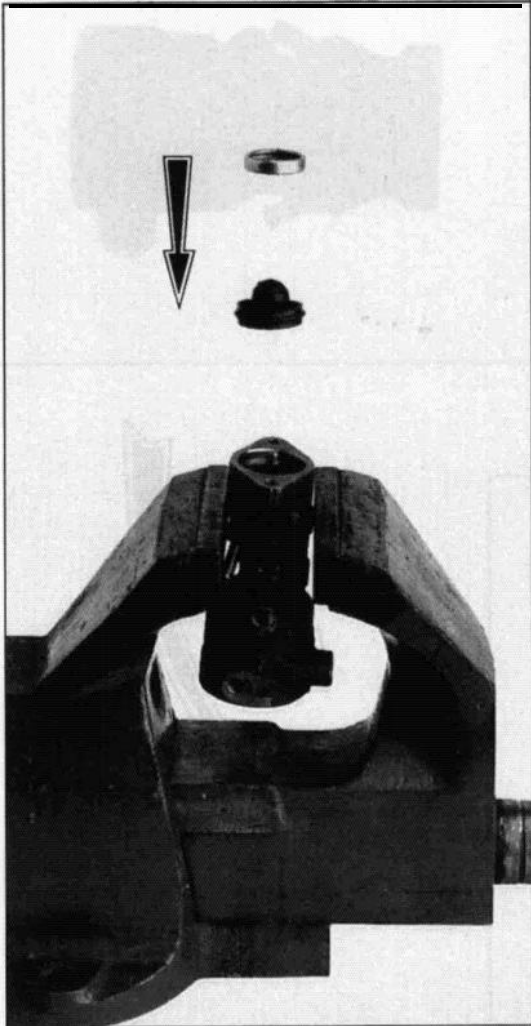
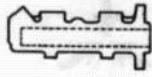
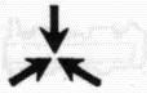

90-468

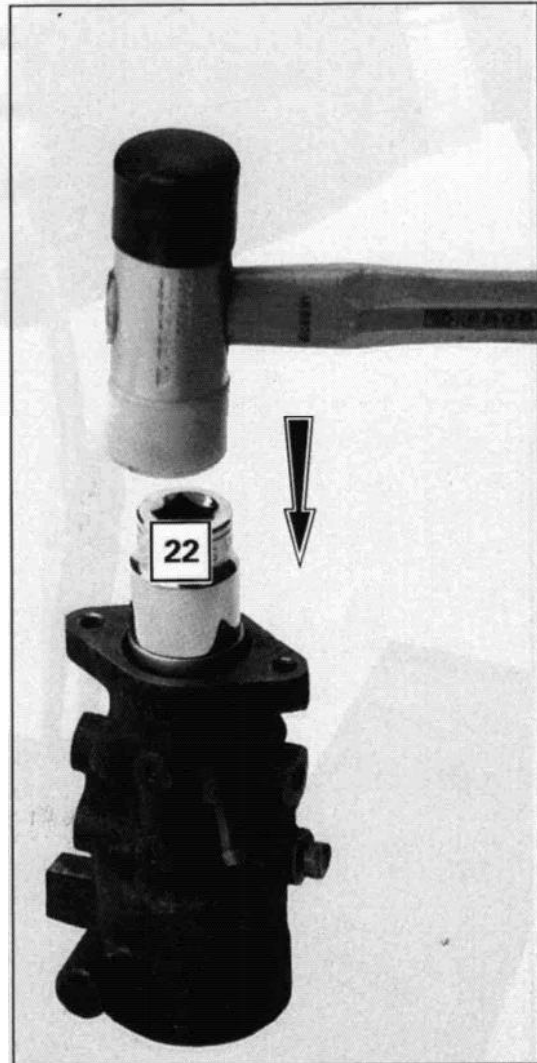
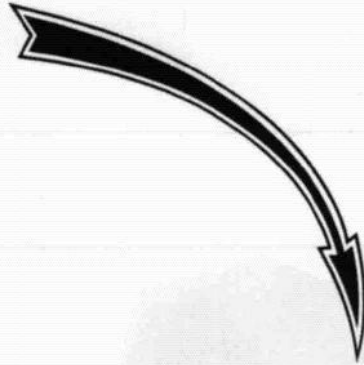

90-462